

USER MANUAL

NORTH AMERICA

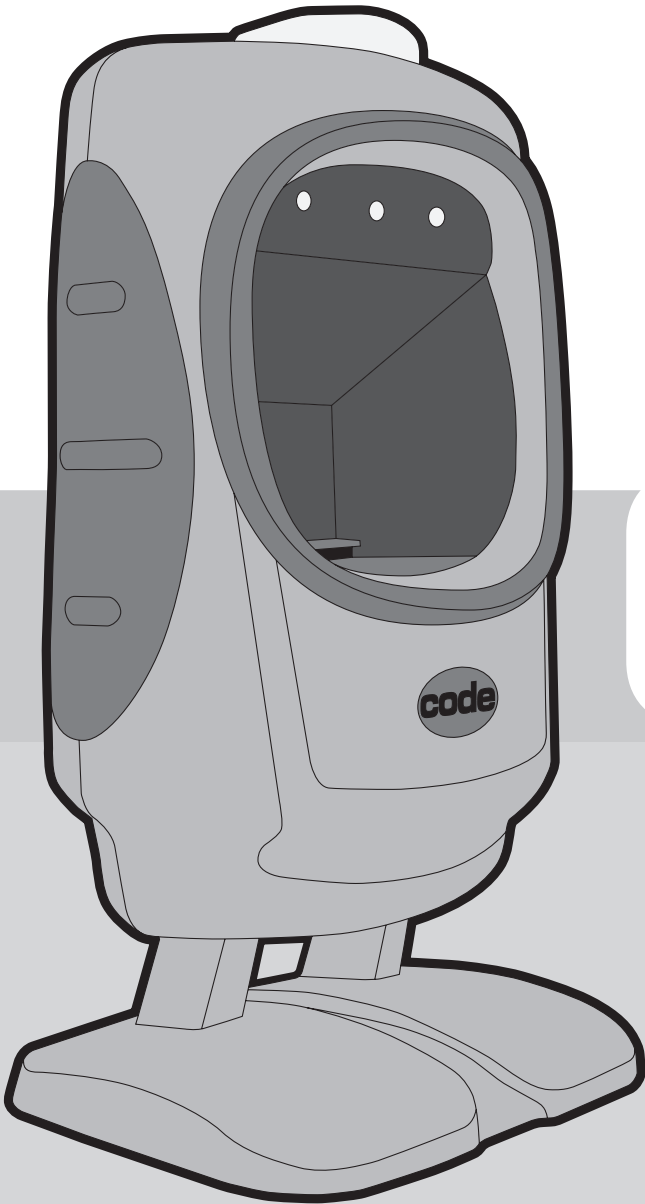

CR5000

MANUAL VERSION 05
RELEASE DATE: DECEMBER 2017



www.codecorp.com



Configuration Guide



[YouTube.com/codecorporation](https://www.youtube.com/codecorporation)

code[®]
REVOLUTIONIZING BARCODE READING

Statement of Agency Compliance



The Code Reader™ 5000 (CR5000) has been tested for compliance with FCC regulations and was found to be compliant with all applicable FCC Rules and Regulations.

IMPORTANT NOTE: To comply with FCC RF exposure compliance requirements, this device must not be co-located or operate in conjunction with any other antenna or transmitter.



CAUTION: Changes or modifications not expressly approved by the party responsible for compliance could void the user's authority to operate the equipment.

The CR5000 has been tested for compliance to CE standards and guidelines and was found to conform to applicable CE standards:

EN 55022: Class B Radiated Emissions, Class B Conducted Emissions

EN-61000-3-2 (Harmonic Current Measurement)

EN 61000-3-3 (Voltage Flicker Measurement)

EN 55024: EN 61000-4-2 (ESD), EN 61000-4-3 (Radiated RF Immunity), EN 61000-4-4 (Electrical Fast Transients),

EN 61000-4-5 (Lightning Surge), EN 61000-4-6 (Conducted RF Immunity), EN 61000-4-8 (Power-Frequency Magnetic Field),

EN 61000-4-11 (Voltage Dips and Interrupts)

The CR5000 has been tested for compliance to EN 62471 Photobiological Safety, and passes under Risk Group 1 which includes the following warning:

Code voids product warranty if the hard case has been opened or tampered with in any way.

Risk Group 1

WARNING IR emitted from this product. Do not stare at operating lamp

Product tested against EN62471

Code Reader™ 5000 User Manual

Copyright © 2016-2017 Code Corporation.

All Rights Reserved.

The software described in this manual may only be used in accordance with the terms of its license agreement.

No part of this publication may be reproduced in any form or by any means without written permission from Code Corporation. This includes electronic or mechanical means such as photocopying or recording in information storage and retrieval systems.

NO WARRANTY. This technical documentation is provided AS-IS. Further, the documentation does not represent a commitment on the part of Code Corporation. Code Corporation does not warrant that it is accurate, complete or error free. Any use of the technical documentation is at the risk of the user. Code Corporation reserves the right to make changes in specifications and other information contained in this document without prior notice, and the reader should in all cases consult Code Corporation to determine whether any such changes have been made. Code Corporation shall not be liable for technical or editorial errors or omissions contained herein; nor for incidental or consequential damages resulting from the furnishing, performance, or use of this material. Code Corporation does not assume any product liability arising out of or in connection with the application or use of any product or application described herein.

NO LICENSE. No license is granted, either by implication, estoppel, or otherwise under any intellectual property rights of Code Corporation. Any use of hardware, software and/or technology of Code Corporation is governed by its own agreement.

The following are trademarks or registered trademarks of Code Corporation:

CodeXML®, Maker, QuickMaker, CodeXML® Maker, CodeXML® Maker Pro, CodeXML® Router, CodeXML® Client SDK, CodeXML® Filter, HyperPage, CodeTrack, GoCard, GoWeb, ShortCode, GoCode®, Code Router, QuickConnect Codes, Rule Runner®, Cortex®, CortexRM, CortexMobile, Code®, Code Reader, CortexAG, CortexStudio, CortexTools®, Affinity®, and CortexDecoder®.

All other product names mentioned in this manual may be trademarks of their respective companies and are hereby acknowledged.

The software and/or products of Code Corporation include inventions that are patented or that are the subject of patents pending. A complete list of patents are available at www.codecorp.com/legal/patents.php.

The Code Reader software uses the Mozilla SpiderMonkey JavaScript engine, which is distributed under the terms of the Mozilla Public License Version 1.1.

The Code Reader software is based in part on the work of the Independent JPEG Group.

Code Corporation, 12393 S. Gateway Park Place, Ste. 600, Draper, Utah 84020

www.codecorp.com

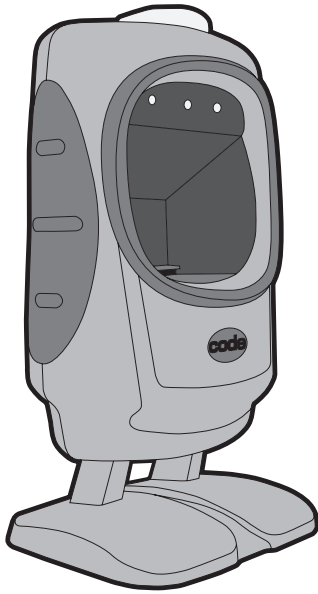

Table of Contents

1.0 - Included Items.....	4
2.0 - Attaching and Detaching a Cable.....	5
3.0 - RS232 and USB Set Up.....	5
4.0 - T500 Cable Set Up.....	6
5.0 - Using a CR5000 in Presentation Mode.....	7
6.0 - Using a CR5000 in Handheld Mode.....	7
7.0 - Reading Ranges.....	7
8.0 - Reader Feedback.....	8
9.0 - Symbologies Defaulted On.....	8
10.0 - Symbologies Defaulted Off.....	8
11.0 - Configuring a CR5000.....	9
12.0 - CR5000AV.....	9
13.0 - Reader ID & Firmware Version.....	10
14.0 - CR5000 Overall Dimensions.....	11
15.0 - USB Cable Example with Pinouts.....	11
16.0 - RS232 Cable Example with Pinouts.....	12
17.0 - Reader Pinouts.....	12
18.0 - CR5000 Maintenance.....	12
19.0 - Warranty.....	13



1.0 - Included Items (if Ordered)



CR5000
(Model #: CR5020 or CR5025)

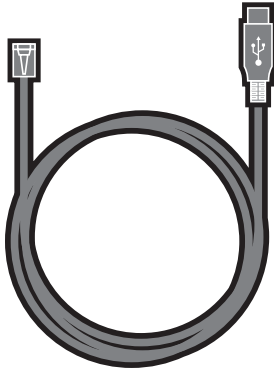

USB 2.0 Cable

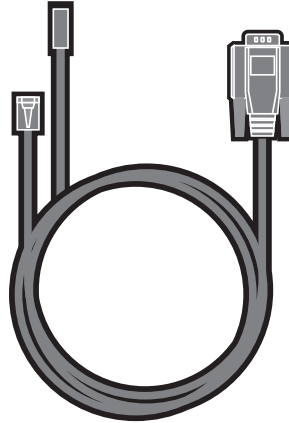

RS232 Cable

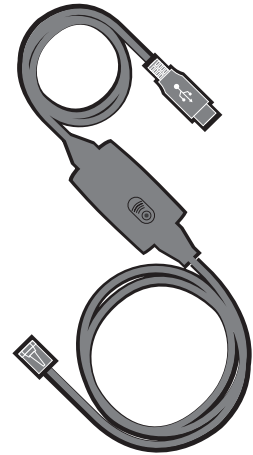

T500 Cable

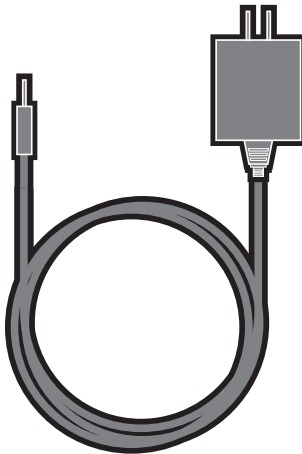

5VDC
Power Supply

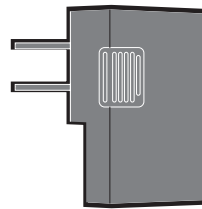

Power Adapter



2.0 - Attaching and Detaching a Cable

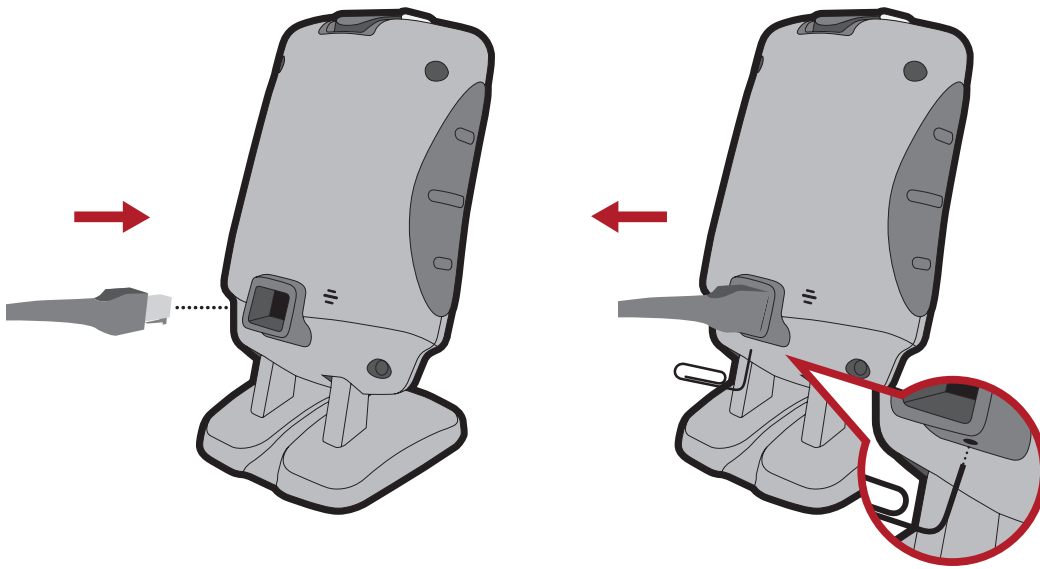

3.0 - RS232 and USB Set Up

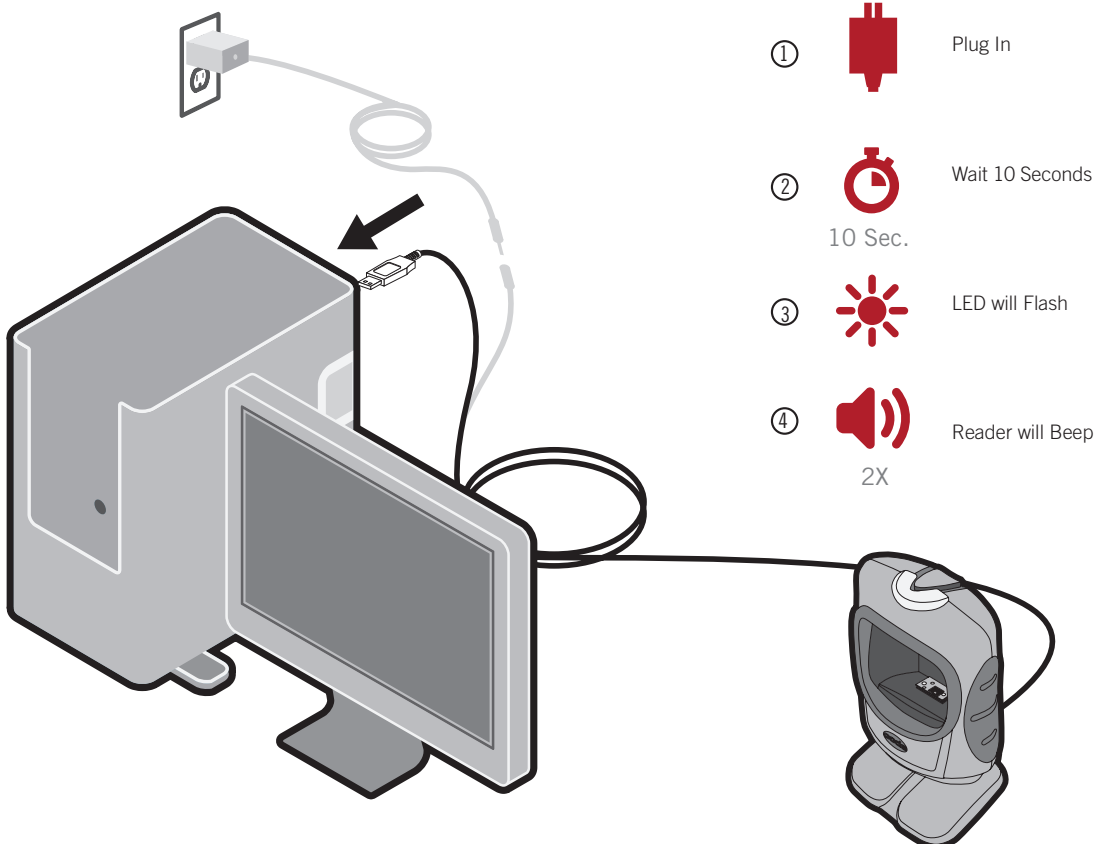

4.0 - T500 Cable Set Up

The T500 cable has an embedded Bluetooth module that allows the CR5000 (minimum firmware version 1160 required) to connect to a tablet, smartphone, or other Bluetooth-enabled device. When the CR5000 is first taken out of the box, plugged into the T500, and powered up, the Bluetooth module will be in discoverable mode, which means a host Bluetooth device may pair with the CR5000 by choosing "Code T500" from the list of available devices shown in the host device's Bluetooth menu (typically under "Settings", but varies by device).

By default, the CR5000 will connect using the HID Keyboard communication protocol. This will send scanned data to the application that has focus on the host device as if the user was typing the data with a keyboard. The communication protocol can be changed using the configuration codes located at www.codecorp.com/ConfigGuide.

For tighter integration with iOS applications, an SDK is available on the Code website at www.codecorp.com/downloads.php.

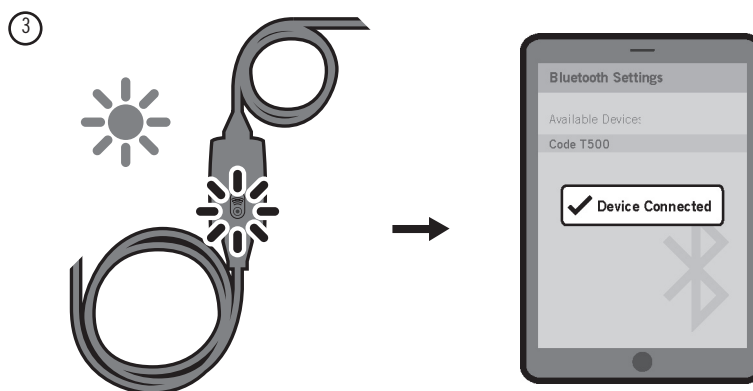
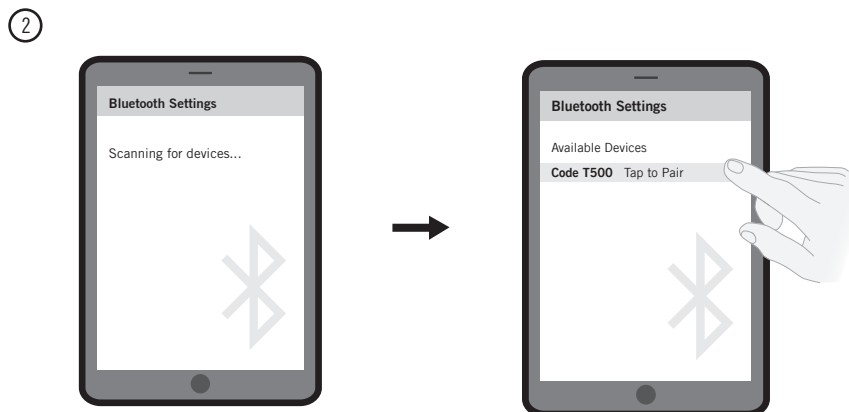
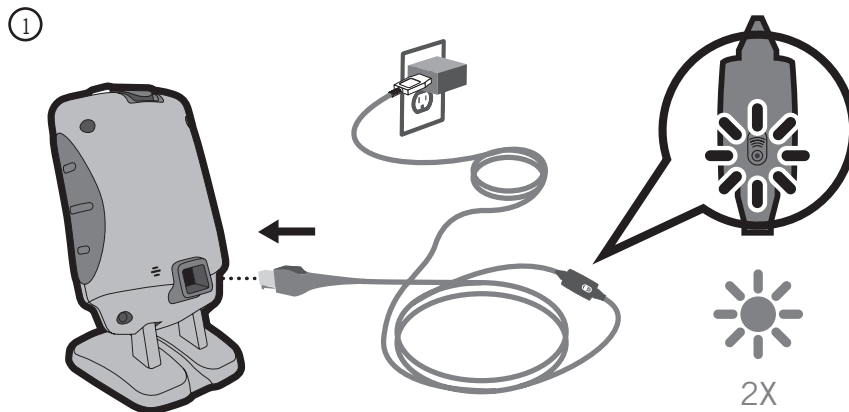

5.0 - Using a CR5000 in Presentation Mode

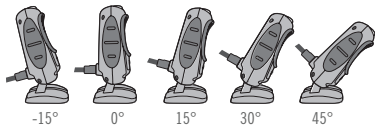
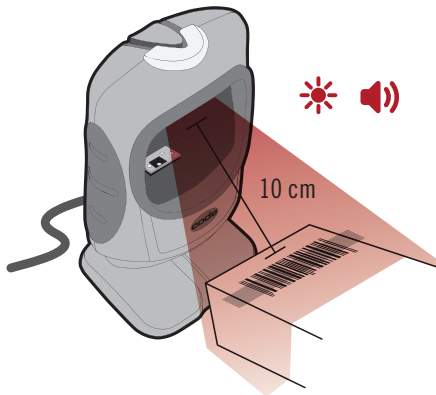

6.0 - Using a CR5000 in Handheld Mode

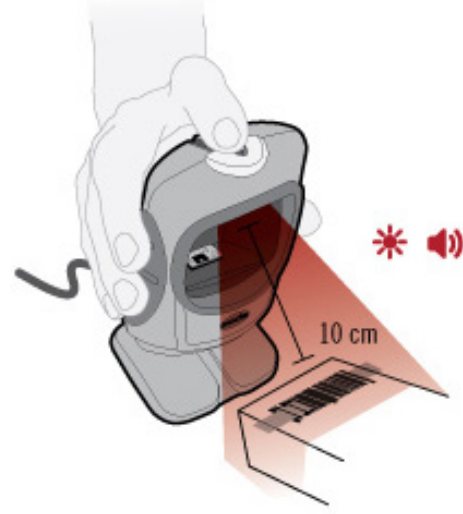











7.0 - Reading Ranges

CR5000 Performance				
Test Barcode	Presentation Mode (Default)		Handheld Mode	
	Min Inches (mm)	Max Inches (mm)	Min Inches (mm)	Max Inches (mm)
5.8mil PDF	0" (0 mm)	2.0" (50 mm)	0.4" (10 mm)	4" (100 mm)
6.3mil DM	0" (0 mm)	2.4" (60 mm)	0.4" (10 mm)	4.5" (115 mm)
6.6mil PDF	0.4" (10 mm)	2.6" (65 mm)	0.4" (10 mm)	4.5" (115 mm)
10mil DM	0.4" (10 mm)	3.5" (90 mm)	0.4" (10 mm)	5.5" (140 mm)
13mil UPC	0.4" (10 mm)	4.9" (125 mm)	0.4" (10 mm)	7.5" (190 mm)
15 mil DM	0.4" (10 mm)	4.5" (115 mm)	0.4" (10 mm)	6.9" (175 mm)
20mil DM	0.4" (10 mm)	6.1" (155 mm)	0.4" (10 mm)	8.0" (205 mm)

Note: Handheld working ranges are a combination of both the wide and high density fields. All samples were high quality barcodes and were read along a physical center line at a 10° angle. Default AGC settings were used. Accuracy= +/- 10%.



8.0 - Reader Feedback

Scenario	Top LED Light	Sound
CR5000 Successfully Powers Up		 1x
CR5000 Successfully Enumerates with Host (via cable)		 1x
Attempting to Decode		None
Successful Decode and Data Transfer		 1x
Configuration Code Successfully Decoded and Processed		 2x
Configuration Code Successfully Decoded but Wasn't Successfully Processed		 4x

9.0 - Symbologies Defaulted On

The following are symbologies that have a default of ON. To turn symbologies on or off, scan the symbology barcodes located in the CR5000 Configuration Guide located at website at www.codecorp.com.

1D: Codabar, Code 39, Code 93, Code 128, All GS1 DataBar, IATA 2 of 5, Interleaved 2 of 5, UPC/EAN/JAN

Stacked 1D: PDF417

2D: Aztec, Data Matrix, Micro QR Code, QR Code

10.0 - Symbologies Defaulted Off

Code barcode readers can read a number of barcode symbologies that are not enabled by default. To turn symbologies on or off, scan the symbology barcodes located in the CR5000 Configuration Guide located on our website at www.codecorp.com/files.php.

1D: BC412, Code 11, Code 32, Matrix 2 of 5, MSI Plessey, NEC 2 of 5, Pharmacode, Plessey, Straight 2 of 5, Telepen, Trioptic,

Stacked 1D: Codablock F, Code 49, MicroPDF

2D: Data Matrix Rectangular Extension, Grid Matrix, Han Xin

Postal: Australian Post, Canada Post, Intelligent Mail, Japan Post, KIX Code, Korea Post, Planet, Post-net, UK Royal Mail, UPU ID-tags

DPM: All

Proprietary: GoCode® (license required)



11.0 - Configuring a CR5000

The online Configuration Guide Generator found at www.codecorp.com/ConfigGuide may be used to quickly configure a CR5000 to desired settings.

12.0 - CR5000AV

The CR5000AV (Model# CR5025) is stand-alone age verification solution that does not require a PC or manual management of data to alert a clerk of an underage patron. When reading an AAMVA-compliant barcoded Driver License, the CR5000AV is enabled by default to alert users if a patron is under the age of 21.

The CR5000AV verifies the age of a patron using its Real Time Clock (RTC) which is set during the manufacturing process. The RTC can be changed to reflect local time, the primary minimum age setting can be changed, and a secondary age set with the online Configuration Generator found at www.codecorp.com/ConfigGuide, or with the CortexTools® utility that can be downloaded at www.codecorp.com/downloads.php.

As noted, the default setting for the CR5000AV is that the primary age is set to 21. There is no secondary age set. In this configuration, if a valid ID is read and the patron's age is equal to or greater than the primary age, the CR5000AV will flash the Green LED and play an ascending three-beep tone. If a valid ID is read and the patron is under the primary age, or the ID is expired, the CR5000AV will flash the Red LED and play a long, low tone.

If the secondary age is set, it tells the reader to test for an age range. For instance, if the primary age is set to 21 and the secondary age is set to 18, then:

Scenario	Top LED Light	Sound
If a valid ID is read and the patron's age is equal to or greater than the primary age.	Flashes green	Ascending three-beep tone
If a valid ID is read and the patron is under the secondary age, or the ID is expired.	Flashes red	Long, low tone
If a valid ID is read, and the patron's age is greater than or equal to the secondary age, but less than the primary age. Note: The CR5000AV will also give this indication if an ID isn't properly formatted.	Flashes yellow	Alternating beeps

Note: If the secondary age is set higher than the primary age, it is ignored.

If you have questions about a specific Identification or Driver License, please contact support@codecorp.com.



13.0 - Reader ID and Firmware Version

To find out the Reader ID and firmware version, open a text editor program (i.e., Notepad, Microsoft Word, etc.) and read the Reader ID and Firmware configuration barcode:

Reader ID and Firmware



A text string indicating the firmware version and CR5000 ID number will be displayed.
 example: Xap/06760456none0020094903A060000070007001500540000/cd(12.3.2)(see below):

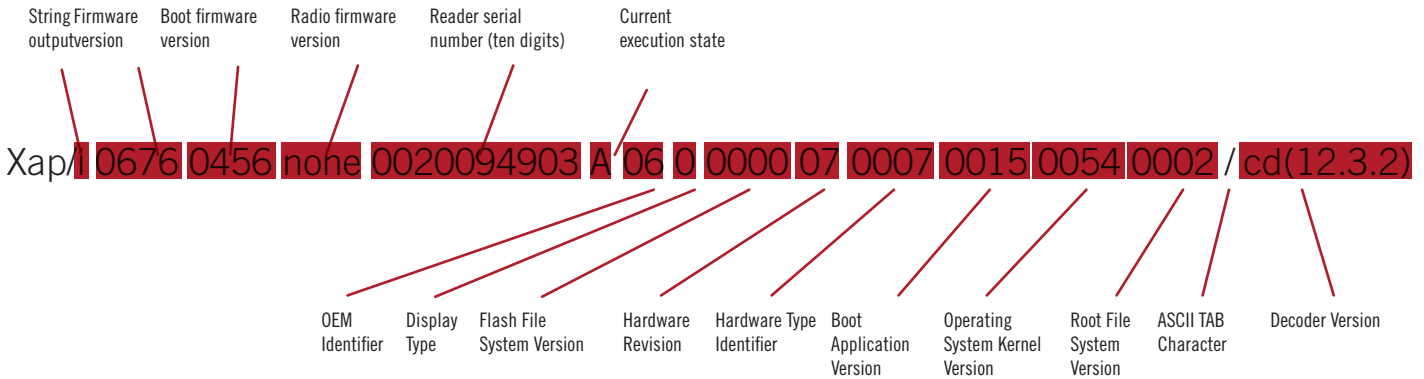

Note: Code will periodically release new firmware for CR5000 readers. For information on latest firmware visit our website at www.codecorp.com/codesupport.php.



14.0 - CR5000 Overall Dimensions

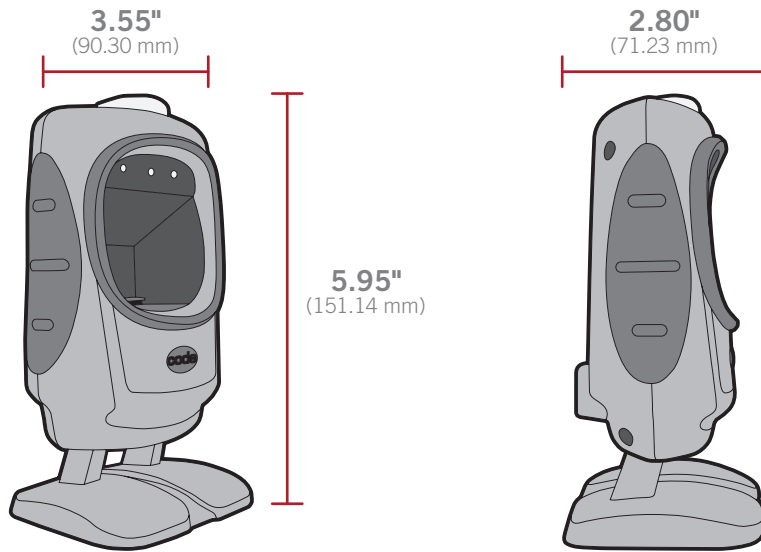

15.0 - USB Cable Example with Pinouts

NOTES:

1. Part to be ROHS and Reach compliant.
2. Maximum Voltage Tolerance = 5V +/- 10%.
3. Caution: Exceeding the maximum voltage will void manufacturer warranty.

CONNECTOR A	NAME	CONNECTOR B
1	VIN	1
2	D-	2
3	D+	3
4	GND	10
SHELL	SHIELD	N/C

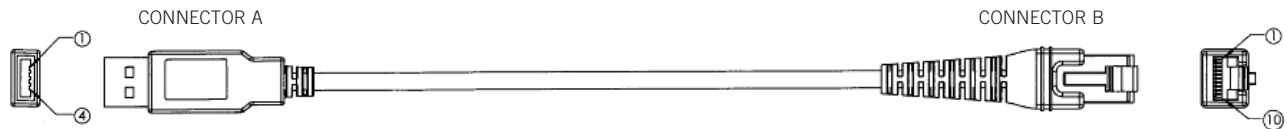

16.0 - RS232 Cable Example with Pinouts

NOTES:

1. Part to be ROHS and Reach compliant.
2. Maximum Voltage Tolerance = 5V +/- 10%.
3. Caution: Exceeding the maximum voltage will void manufacturer warranty.

CONNECTOR A	NAME	CONNECTOR B	CONNECTOR C
1	VIN	9	TIP
4	TX	2	
5	RTS	8	
6	RX	3	
7	CTS	7	
10	GND	5	RING
N/C	SHIELD	SHELL	

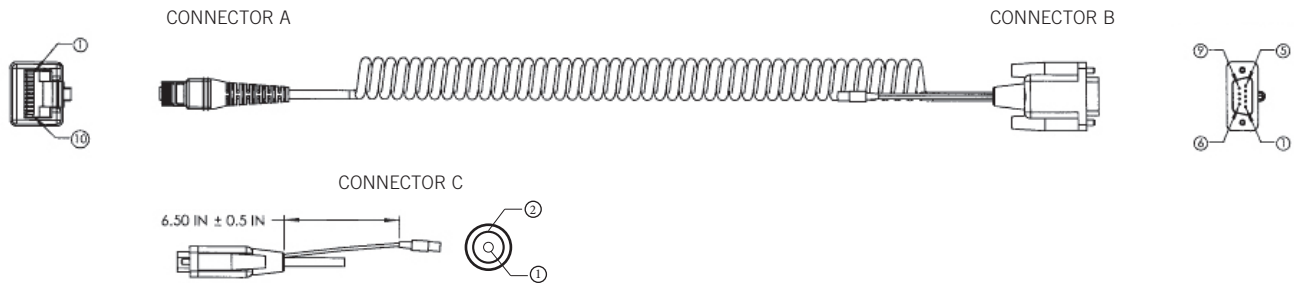

*Diode on Pin 9 of Connector B prevents back-powering of host.

17.0 - Reader Pinouts

The connector on the CR5000 is an RJ-50 (10P-10C). The pinouts are as follows:

Pin 1	+VIN (5v)	Pin 6	RS232 RX (input to reader)
Pin 2	USB_D-	Pin 7	RS232 CTS (input to reader)
Pin 3	USB_D+	Pin 8	Reserved for EAS
Pin 4	RS232 TX (output from reader)	Pin 9	Reserved for EAS
Pin 5	RS232 RTS (output from reader)	Pin 10	Ground

18.0 - CR5000 Maintenance

The CR5000 device needs only a minimum of maintenance to operate. A few tips are given below for maintenance suggestions.

Cleaning the CR5000 Window

CR5000 window should be clean to allow the best performance of the device. The window is the clear plastic piece inside the head of the reader. Do not touch the window. Your CR5000 uses CMOS technology that is much like a digital camera. A dirty window may stop the CR5000 from reading barcodes. If the window becomes dirty, clean it with a soft, non-abrasive cloth or a facial tissue (no lotions or additives) that has been moistened with water.

Technical Support and Returns

For returns or technical support visit www.codecorp.com/codesupport.php.



19.0 - Warranty

Visit www.codecorp.com/legal/warranty.php to view warranty periods.

Limited Warranty. Code warrants each Code product against defects in materials and workmanship under normal use for the Warranty Coverage Term applicable to the product as described at www.codecorp.com/legal/warranty/term.php. If a hardware defect arises and a valid warranty claim is received by Code during the Warranty Coverage Term, Code will either: i) repair a hardware defect at no charge, using new parts or parts equivalent to new in performance and reliability; ii) replace the Code product with a product that is new or refurbished product with equivalent functionality and performance, which may include replacing a product that is no longer available with a newer model product; or ii) in the case of failure with any software, including embedded software included in any Code product, provide a patch, update, or other work around. All replaced products become the property of Code. All warranty claims must be made using Code's RMA process.

Exclusions. This warranty does not apply to: i) cosmetic damage, including but not limited to scratches, dents, and broken plastic; ii) damage resulting from use with non-Code products or peripherals, including batteries, power supplies, cables, and docking station/cradles; iii) damage resulting from accident, abuse, misuse, flood, fire or other external causes, including damage caused by unusual physical or electrical stress, immersion in fluids or exposure to cleaning products not approved by Code, puncture, crushing, and incorrect voltage or polarity; iv) damage resulting from services performed by anyone other than a Code authorized repair facility; v) any product that has been modified or altered; vi) any product on which the Code serial number has been removed or defaced. If a Code Product is returned under a warranty claim and Code determines, in Code's sole discretion, that the warranty remedies do not apply, Code will contact Customer to arrange either: i) repair or replace the Product; or ii) return the Product to Customer, in each case at Customer's expense.

Non Warranty Repairs. Code warrants its repair/replacement services for ninety (90) days from the date of shipment of the repaired/replacement product to the Customer. This warranty applies to repairs and replacements for: i) damage excluded from the limited warranty described above; and ii) Code Products on which the limited warranty described above has expired (or will expire within such ninety (90) day warranty period). For repaired product this warranty covers only the parts that were replaced during the repair and the labor associated with such parts.

No Extension of Term of Coverage. Product that is repaired or replaced, or for which a software patch, update, or other work around is provided, assumes the remaining warranty of the original Code Product and does not extend the duration of the original warranty period.

Software and Data. Code is not responsible for backing up or restoring any of software, data, or configuration settings, or reinstalling any of the foregoing on products repaired or replaced under this limited warranty.

Shipping and Turn Around Time. The estimated RMA turn-around time from receipt at Code's facility to shipment of the repaired or replaced product to Customer is ten (10) business days. An expedited turn-around time may apply to products covered under certain CodeOne Service Plans. Customer is responsible for shipping and insurance charges for shipping Code Product to Code's designated RMA facility and repaired or replaced product is returned with shipping and insurance paid by Code. Customer is responsible for all applicable taxes, duties, and similar charges.

Transfer. If a customer sells a covered Code Product during the Warranty Coverage Term, then that coverage may be transferred to the new owner by written notification from the original owner to Code Corporation at:

CodeOne Service Center
12393 South Gateway Park Place, Suite 600
Draper, UT 84020

Limitation on Liability. Code's performance as described herein shall be Code's entire liability, and the Customer's sole remedy, resulting from any defective Code product. Any claim that Code has failed to perform its warranty obligations as described herein must be made within six (6) months of the alleged failure. Code's maximum liability related to its performance, or failure to perform, as described herein shall be limited to the amount paid by Customer for the Code product that is subject to the claim. In no event will either party be liable for any lost profits, lost savings, incidental damage, or other economic consequential damages. This is true even if the other party is advised of the possibility of such damages.

EXCEPT AS MAY BE OTHERWISE PROVIDED BY APPLICABLE LAW, THE LIMITED WARRANTIES DESCRIBE HEREIN REPRESENT THE ONLY WARRANTIES CODE MAKES WITH RESPECT TO ANY PRODUCT. CODE DISCLAIMS ALL OTHER WARRANTIES, WHETHER EXPRESSED OR IMPLIED, ORAL OR WRITTEN, INCLUDING WITHOUT LIMITATION IMPLIED WARRANTIES OF MERCHANTABILITY, FITNESS FOR A PARTICULAR PURPOSE AND NON-INFRINGEMENT.

THE REMEDIES DESCRIBED HEREIN REPRESENT CUSTOMER'S EXCLUSIVE REMEDY, AND CODE'S ENTIRE RESPONSIBILITY, RESULTING FROM ANY DEFECTIVE CODE PRODUCT. CODE SHALL NOT BE LIABLE TO CUSTOMER (OR TO ANY PERSON OR ENTITY CLAIMING THROUGH CUSTOMER) FOR LOST PROFITS, LOSS OF DATA, DAMAGE TO ANY EQUIPMENT WITH WHICH THE CODE PRODUCT INTERFACES (INCLUDING ANY MOBILE TELEPHONE, PDA, OR OTHER COMPUTING DEVICES), OR FOR ANY SPECIAL, INCIDENTAL, INDIRECT, CONSEQUENTIAL OR EXEMPLARY DAMAGES ARISING OUT OF OR IN ANY MANNER CONNECTED WITH THE PRODUCT, REGARDLESS OF THE FORM OF ACTION AND WHETHER OR NOT CODE HAS BEEN INFORMED OF, OR OTHERWISE MIGHT HAVE ANTICIPATED, THE POSSIBILITY OF SUCH DAMAGES.

*North America Warranty Period.

