

USER MANUAL

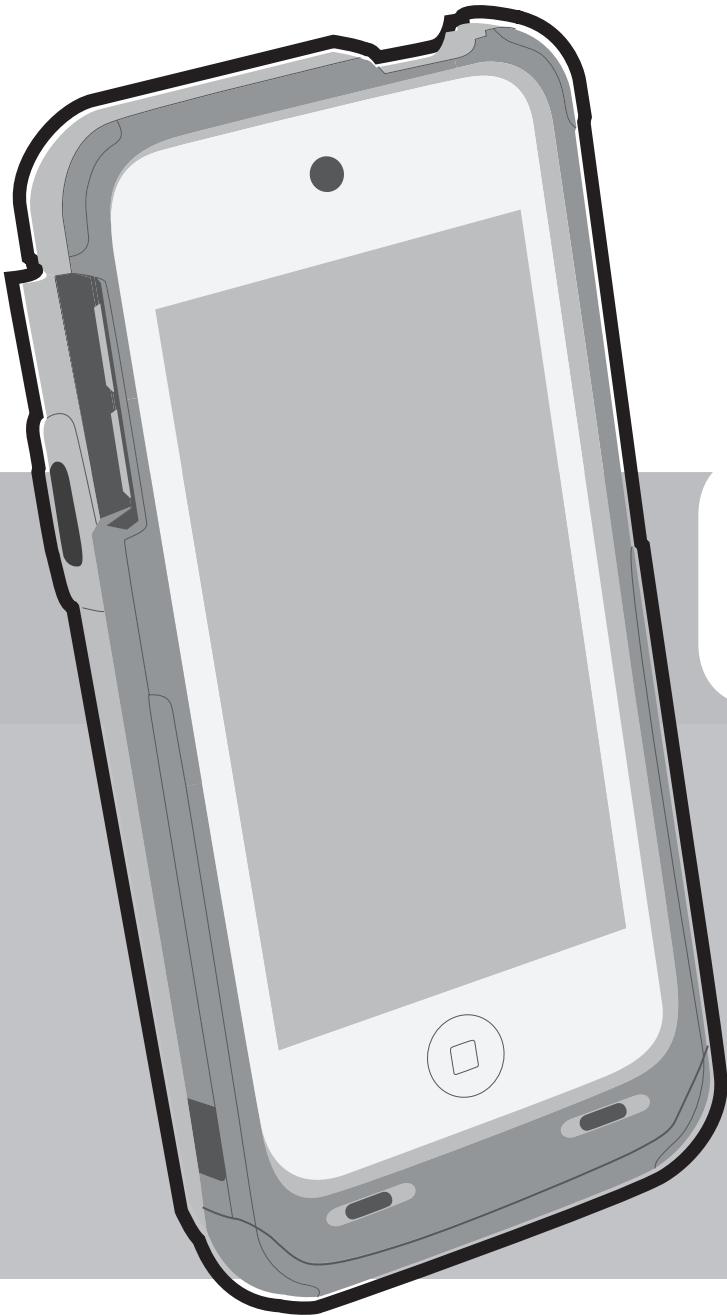

CR4300

Compatible with Apple® iPhone® 6/6s,
and iPod® (5th/6th Generation)

MANUAL VERSION: 02
RELEASE DATE: FEBRUARY 2017



www.codecorp.com



[YouTube.com/codecorporation](https://www.youtube.com/codecorporation)

Statement of Agency Compliance



The Code Reader™ 4300 (CR4300) has been tested for compliance with FCC regulations and was found to be compliant with all applicable FCC Rules and Regulations.



IMPORTANT NOTE: To comply with FCC RF exposure compliance requirements, this device must not be co-located or operate in conjunction with any other antenna or transmitter.



CAUTION: Changes or modifications not expressly approved by the party responsible for compliance could void the user's authority to operate the equipment.

The CR4300 has been tested for compliance to CE standards and guidelines and was found to conform to applicable CE standards, specifically the EMC requirements EN 55024, ESD EN 61000-4-2, Radiated RF Immunity EN 61000-4-3, ENV 50204, EFT EN 61000-4-4, Conducted RF Immunity EN 61000-4-6, EN 55022, Class B Radiated Emissions, and Class B Conducted Emissions.

The CR4300 has been tested and certified in compliance with the Technical Regulations Conformity Certification of Specified Radio Equipment (ordinance of MPT N°.37. 1981), Article 2, Paragraph 1, Item 19.

Code voids product warranty if the hard case has been opened or tampered with in any way.

The CR4300 meets all safety and quality standards in accordance to EN 60950-1:2006/A11:2009/A1:2010.

CR4300 FCC, Industry Canada and ICES Compliance

FCC:

This device complies with part 15 of the FCC Rules. Operation is subject to the following two conditions: (1) This device may not cause harmful interference, and (2) this device must accept any interference received, including interference that may cause undesired operation.

NOTE: This equipment has been tested and found to comply with the limits for a Class B digital device, pursuant to part 15 of the FCC Rules. These limits are designed to provide reasonable protection against harmful interference in a residential installation. This equipment generates, uses and can radiate radio frequency energy and, if not installed and used in accordance with the instructions, may cause harmful interference to radio communications. However, there is no guarantee that interference will not occur in a particular installation.

If this equipment does cause harmful interference to radio or television reception, which can be determined by turning the equipment off and on, the user is encouraged to try to correct the interference by one or more of the following measures:

- Reorient or relocate the receiving antenna.
- Increase the separation between the equipment and receiver.
- Connect the equipment into an outlet on a circuit different from that to which the receiver is connected.
- Consult the dealer or an experienced radio/TV technician for help.

IMPORTANT! Any changes or modifications not expressly approved by the party responsible for compliance could void the user's authority to operate this equipment.

IMPORTANT! Tous les changements ou modifications pas expressément approuvés par la partie responsable de la conformité ont pu vider l'autorité de l'utilisateur pour actionner cet équipement.

FCC Radiation Exposure Statement:

This equipment complies with FCC radiation exposure limits set forth for an uncontrolled environment. This equipment should be installed and operated with minimum distance 20cm between the radiator and your body.

Industry Canada

This device complies with Industry Canada licence-exempt RSS standard(s). Operation is subject to the following two conditions: (1) this device may not cause interference, and (2) this device must accept any interference, including interference that may cause undesired operation of the device.

Le présent appareil est conforme aux CNR d'Industrie Canada applicables aux appareils radio exempts de licence. L'exploitation est autorisée aux deux conditions suivantes : (1) l'appareil ne doit pas produire de brouillage, et (2) l'utilisateur de l'appareil doit accepter tout brouillage radioélectrique subi, même si le brouillage est susceptible d'en compromettre le fonctionnement.

This Class B digital apparatus complies with Canadian ICES-003.

Cet appareil numérique de la classe B est conforme à la norme NMB-003 du Canada.

Important Note:

Radiation Exposure Statement:

This equipment complies with IC radiation exposure limits set forth for an uncontrolled environment. This equipment should be installed and operated with minimum distance 20cm between the radiator and your body.

Note Importante: (Pour l'utilisation de dispositifs mobiles)

Declaration d'exposition aux radiations:

Cet équipement est conforme aux limites d'exposition aux rayonnements IC établies pour un environnement non contrôlé. Cet équipement doit être installé et utilisé avec un minimum de 20 cm de distance entre la source de rayonnement et votre corps.

Code Reader™ 4300 User Manual

Copyright © 2017 Code Corporation.

All Rights Reserved.

The software described in this manual may only be used in accordance with the terms of its license agreement.

No part of this publication may be reproduced in any form or by any means without written permission from Code Corporation. This includes electronic or mechanical means such as photocopying or recording in information storage and retrieval systems.

NO WARRANTY. This technical documentation is provided AS-IS. Further, the documentation does not represent a commitment on the part of Code Corporation. Code Corporation does not warrant that it is accurate, complete or error free. Any use of the technical documentation is at the risk of the user. Code Corporation reserves the right to make changes in specifications and other information contained in this document without prior notice, and the reader should in all cases consult Code Corporation to determine whether any such changes have been made. Code Corporation shall not be liable for technical or editorial errors or omissions contained herein; nor for incidental or consequential damages resulting from the furnishing, performance, or use of this material. Code Corporation does not assume any product liability arising out of or in connection with the application or use of any product or application described herein.

NO LICENSE. No license is granted, either by implication, estoppel, or otherwise under any intellectual property rights of Code Corporation. Any use of hardware, software and/or technology of Code Corporation is governed by its own agreement.

The following are trademarks or registered trademarks of Code Corporation:

CodeXML®, Maker, QuickMaker, CodeXML® Maker, CodeXML® Maker Pro, CodeXML® Router, CodeXML® Client SDK, CodeXML® Filter, HyperPage, CodeTrack, GoCard, GoWeb, ShortCode, GoCode®, Code Router, QuickConnect Code, Rule Runner®, Cortex®, CortexRM, CortexMobile, Code, Code Reader, CortexAG, CortexStudio, CortexTools, Affinity®, CortexDecoder, CortexJPOS, and CortexOPOS.

All other product names mentioned in this manual may be trademarks of their respective companies and are hereby acknowledged.

The software and/or products of Code Corporation include inventions that are patented or that are the subject of patents pending. U.S. Patents: 6997387, 6942152, 7014113, 7070091, 7097099, 7353999, 7519239, 7621453, 8001550, 8011584.

The Code Reader software uses the Mozilla SpiderMonkey JavaScript engine, which is distributed under the terms of the Mozilla Public License Version 1.1. The Code Reader software is based in part on the work of the Independent JPEG Group.

Code, 12393 S. Gateway Park Place, Ste. 600, Draper, Utah 84020

www.codecorp.com

Table of Contents

1.0 - Included if Ordered.....	5
2.0 - Optical Module.....	5
3.0 - Devices Supported.....	6
4.0 - Phone Installation.....	6
5.0 - Charging the CR4300.....	7
6.0 - Powering On the CR4300.....	7
7.0 - Sled Battery Status Indication.....	8
8.0 - Scanning.....	8
9.0 - Uninstall.....	8
10.0 - Symbologies Defaulted On.....	9
11.0 - Symbologies Defaulted Off.....	9
12.0 - Reading Ranges.....	9
13.0 - Software Development Kit (SDK).....	9
14.0 - Using FlexTest.....	10
15.0 - Battery Life Management via the SDK.....	11
16.0 - CR4300 Dimensions.....	12
17.0 - Charging Station Dimensions.....	12
18.0 - Upgrading CR4300 Firmware.....	13
19.0 - CR4300 Maintenance.....	13
20.0 - Warranty.....	13

1.0 - Included if Ordered



CR4300



USB 2.0 Cable

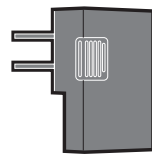

5VDC Power Supply



Optics Locking Insert

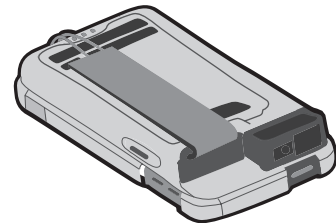

Hand Strap

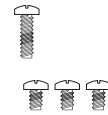

Torx™ T6 Screws

2.0 - Optical Module

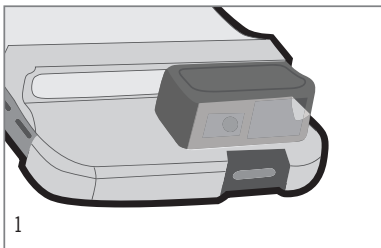

1

Remove protective film from optics before use.

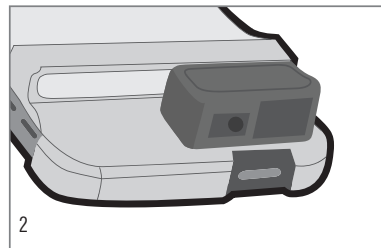

2

Optics can move to allow full camera functionality.

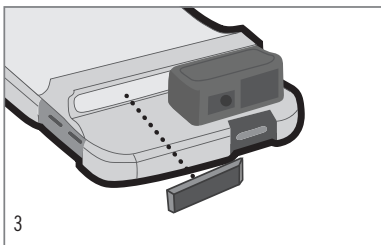

3

Install Optics Locking Insert to keep reading optics locked in place.

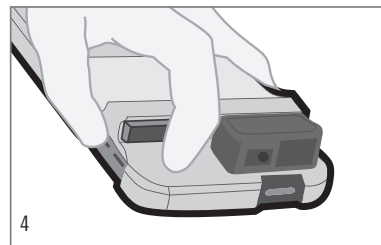

4

3.0 - Devices Supported

The following devices are approved for use with the CR4300:

- iPhone 6
- iPhone 6s
- iPod 5th Generation
- iPod 6th Generation

4.0 - Device Installation

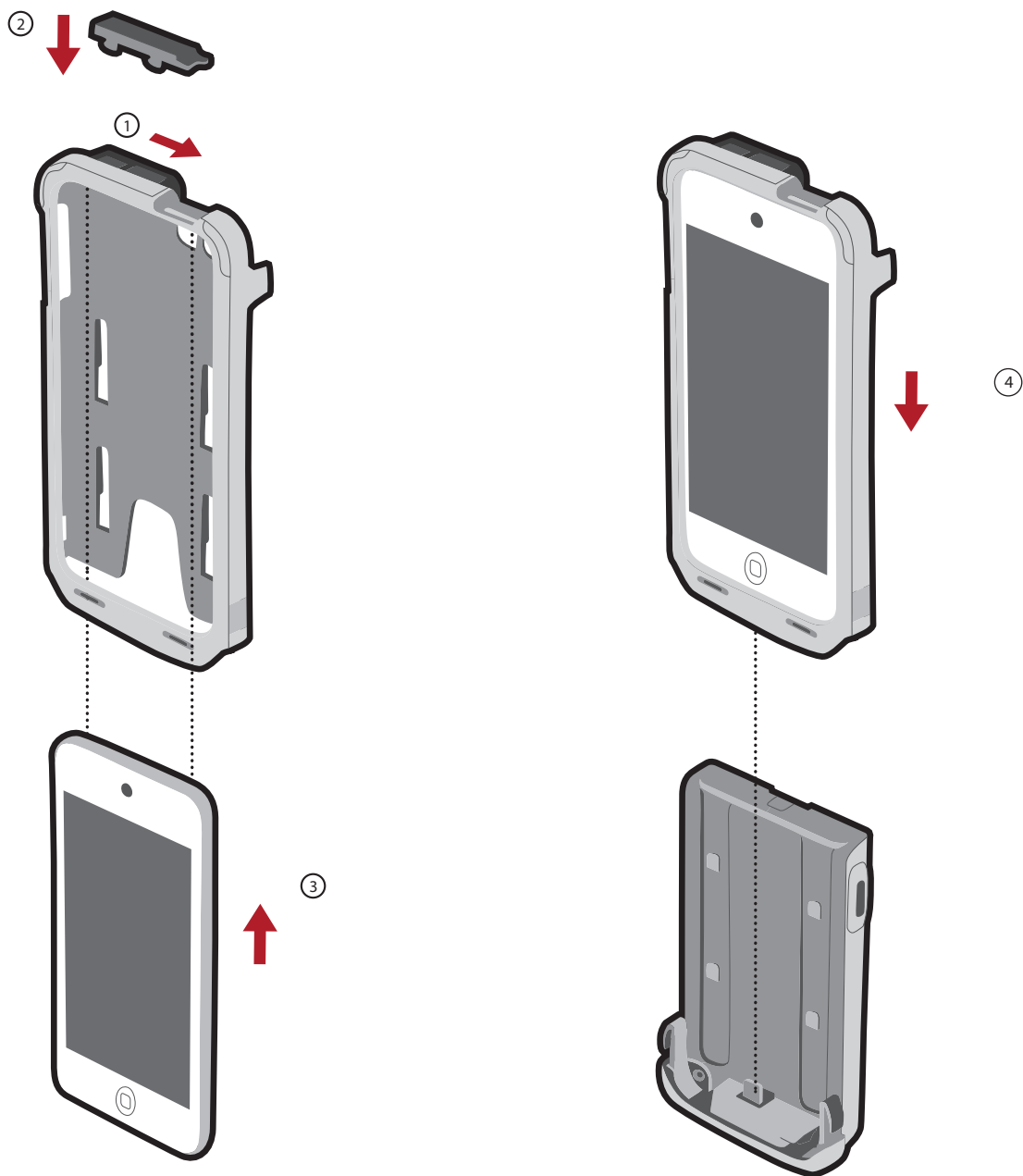

5.0 - Charging the CR4300

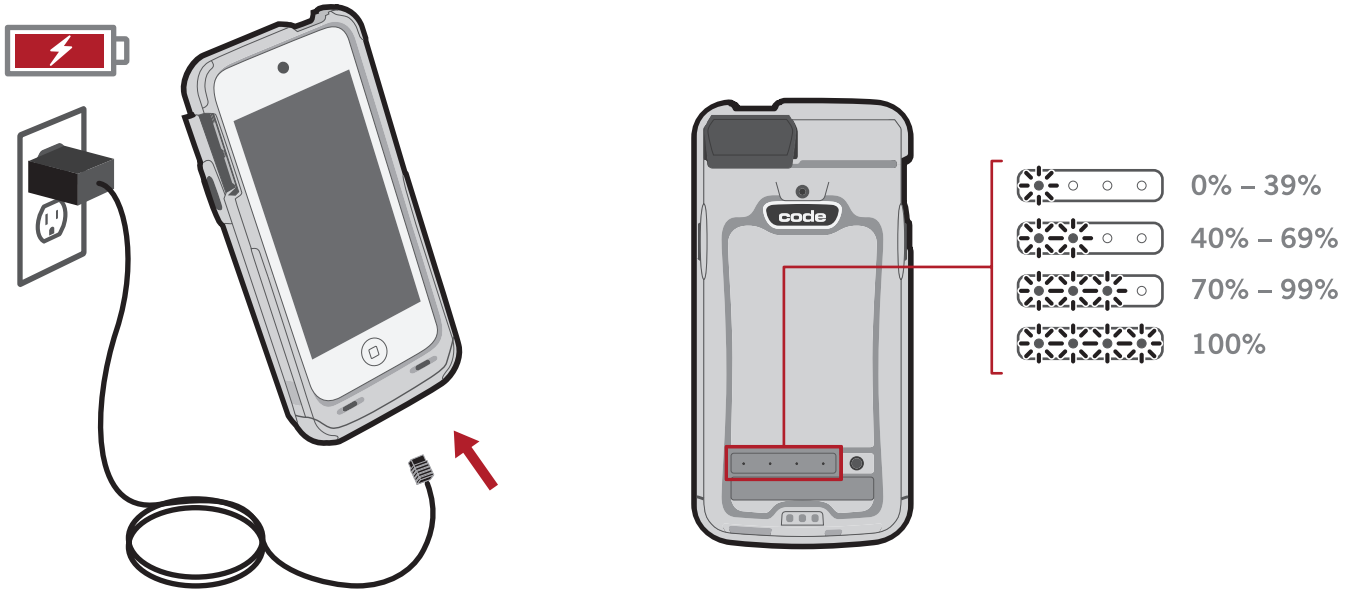

6.0 - Powering On the CR4300

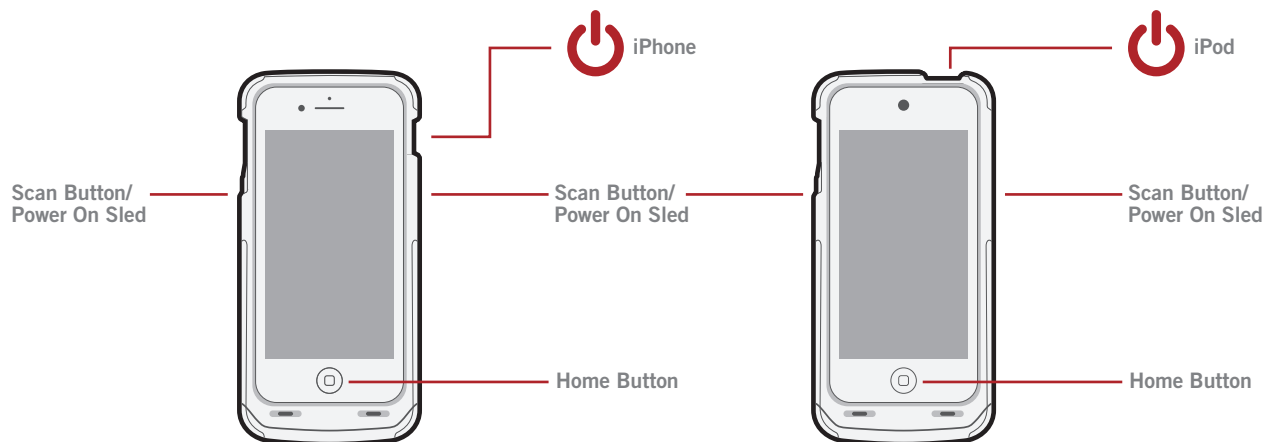

Note: After 10 minutes of inactivity, the CR4300 will turn off. Press the scan buttons or the battery indicator to turn it back on. If a device is placed into the CR4300 when it is off, and that device is off, when the CR4300 is turned on, it will subsequently turn the device on. Please make sure you have the appropriate power saving settings (lock screen, etc.) on your iPod or iPhone to avoid draining the battery too quickly.

7.0 - Battery Status Indication

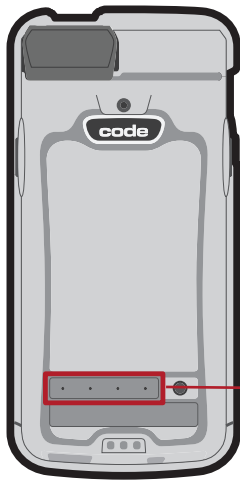

Battery State While Charging	Battery State While Not Charging
0% – 39%	< 10%
40% – 69%	10% – 39%
70% – 99%	40% – 69%
100%	70% – 99%
	100%

8.0 - Scanning

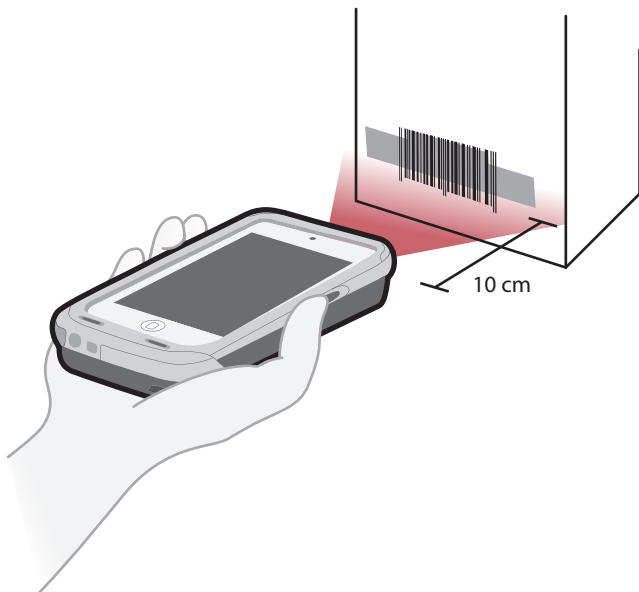

9.0 - Uninstall

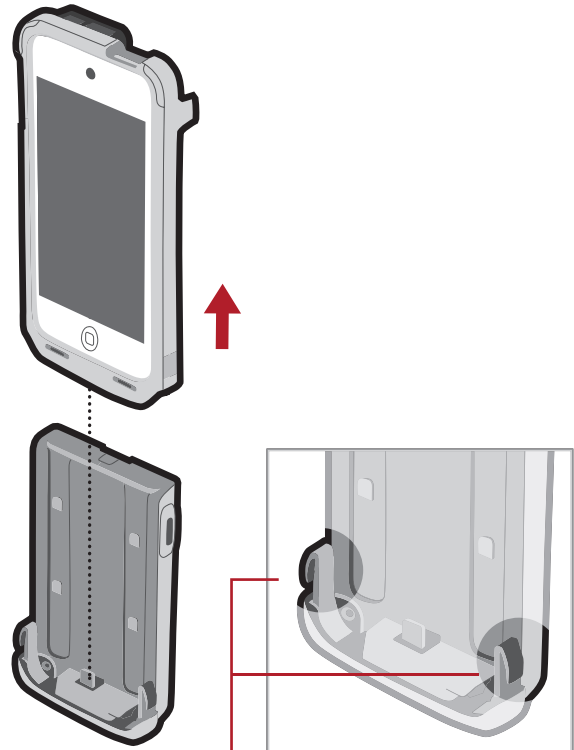

Grip base, squeeze tabs on both sides, and pull carriage upward to uninstall.

10.0 - Symbologies Defaulted On

The following are symbologies are defaulted ON. Symbology settings are controlled by the FlexTest SDK.

Aztec	Data Matrix Rectangle
Codabar	All GS1 DataBar
Code 39	Interleaved 2 of 5
Code 93	MSI Plessey
Code 128	PDF417
Data Matrix	QR Code
	UPC/EAN/JAN

11.0 - Symbologies Defaulted Off

The following are symbologies are defaulted OFF. Symbology settings are controlled by the FlexTest SDK.

Code 11	Maxicode	Standard 2 of 5
Code 32	Matrix 2 of 5	Telepen
Composite	Micro PDF417	Trioptic
Han Xin Code	MSI Plessey	Postal Codes
Hong Kong 2 of 5	NEC 2 of 5	
IATA 2 of 5	Plessey	

12.0 - Reading Ranges

CR4300 Performance		
Test Barcode	Min Inches (mm)	Max Inches (mm)
7.5 mil Code 39	3.1" (80 mm)	9.4" (240 mm)
13 mil UPC	2.4" (60 mm)	19.7" (500 mm)
5 mil Data Matrix	2.4" (60 mm)	4.9" (125 mm)
6.7 mil Data Matrix	2.2" (55 mm)	9.8" (250 mm)
10 mil Data Matrix	2.0" (50 mm)	10.4" (265 mm)
15 mil QR Code	1.6" (40 mm)	17.3" (440 mm)
20.8 mil Data Matrix	1.6" (40 mm)	17.7" (450 mm)

Note: All samples were high quality barcodes and were read along a physical center line at a 10° angle. Default AGC settings were used. Accuracy= +/- 10%.

13.0 - Software Development Kit (SDK)

Code provides an SDK for incorporating barcode reading into your iOS applications. The SDK provides a sample application, FlexTest, which can be compiled in your environment to demonstrate the functionality of a CR4300. The SDK is available on Code's website.

14.0 - Using FlexTest

FlexTest is a software application developed by Code to demonstrate the capabilities of the CR4300. This software app can serve as a reference for programmers who use Code's SDK to build other apps which can be downloaded to the mobile device from the App Store.

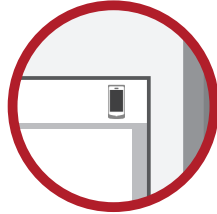



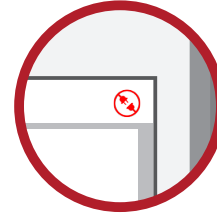

The main application screen displays the iPhone or iPod connection status. If the CR4300 icon appears, the CR4300 is connected to the iPhone or iPod.



If  appears, the CR4300 is not connected to the iPhone or iPod.



FlexTest Button Descriptions

Button	Description
 Scan	Allows you to scan barcodes either with the use of the on-screen "soft" scan button or the scan button located on the side of the CR4300. Scanned barcode data will appear on the main screen of the app.
 Info	Displays a screen containing general information about the reader, such as status, version, firmware, etc.
 Advanced	Additional options that can be enabled/disabled on the CR4300 and its software to demonstrate additional functionality (e.g. symbologies, focus, power preferences)
 More	Allows you to reference additional features of FlexTest.

15.0 - Battery Life Management via the SDK

The FlexTest application demonstrates three power management methodologies for the CR4300. These would need to be implemented by the application developer, and are basically three different ways of controlling the video stream to balance performance and battery consumption. The options are:

- **Maximum Performance:** this setting keeps the video stream on constantly. This gives the snappiest performance, but also drains the battery the fastest. After 30 minutes, the video stream will timeout and will turn back on upon next trigger (soft or hard scan button press).
- **Standard:** this setting pulses the video stream. This gives median performance.
- **Battery Saving:** this setting initiates the video stream upon button press. An iOS limitation causes a delay of up to 500 ms before the video stream will actually start, which may give the perception of slow performance.

If...		Then...
iPhone Battery Status	Sled Battery Status	Sled
Any level	Greater than  15%	WILL charge the iPod/iPhone
Any level	Less than  15%	WILL NOT charge the iPod/iPhone

16.0 - CR4300 Dimensions

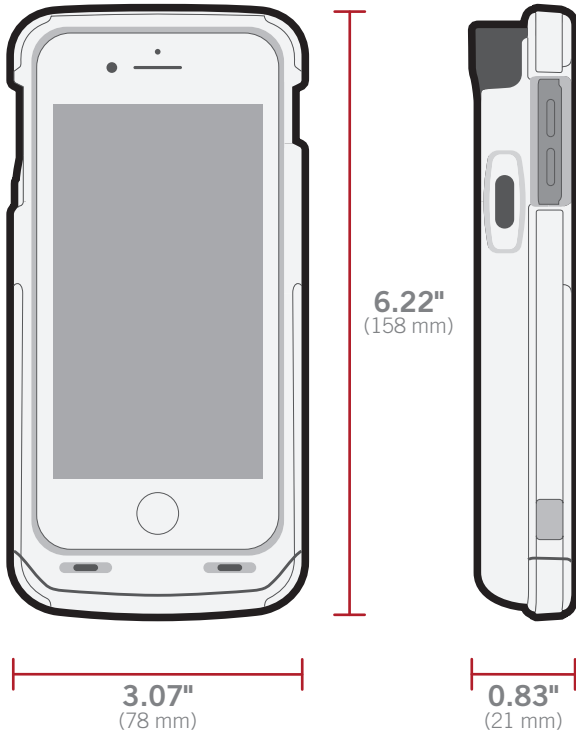

iPhone 6 / iPhone 6s Dimensions

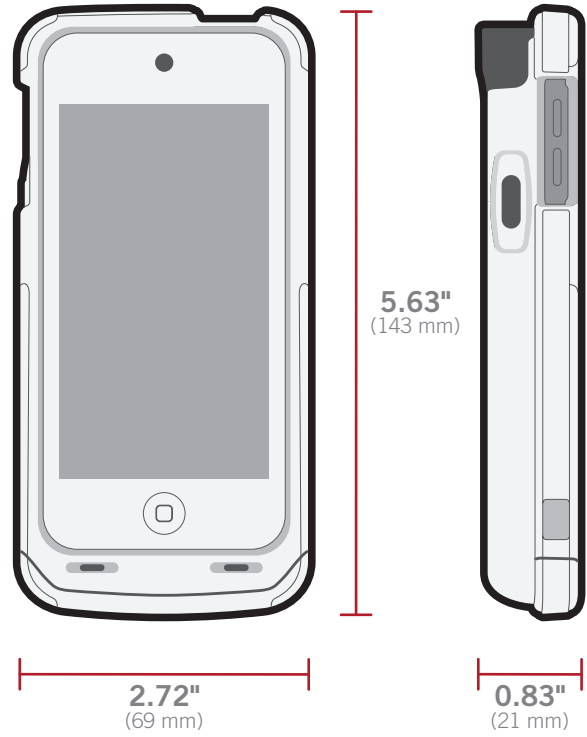

iPod 6th Gen Dimensions

17.0 - Charging Station Dimensions

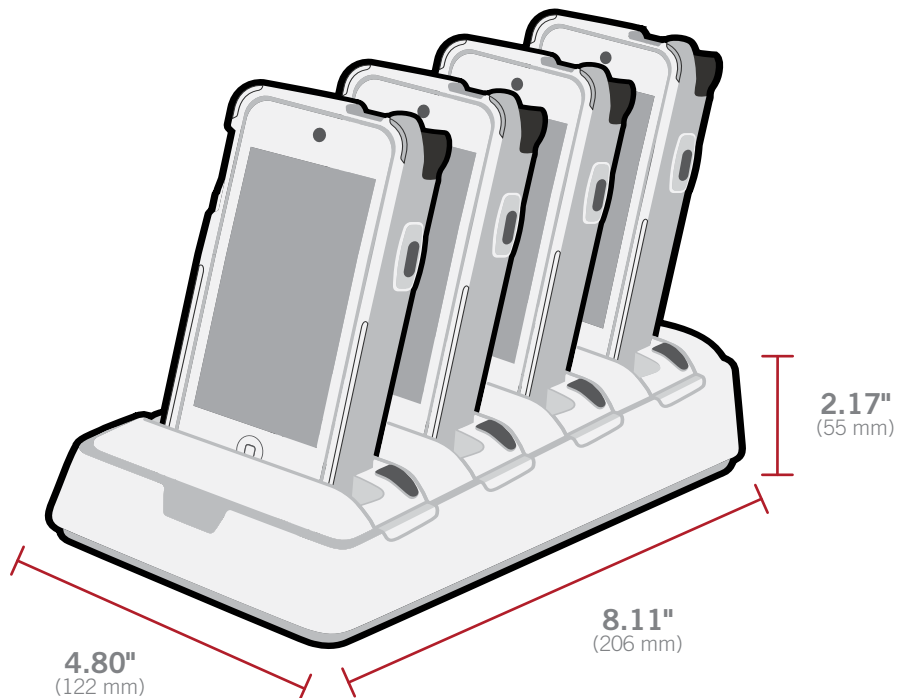

18.0 - Upgrading the CR4300 Firmware

The CR4300 firmware must be updated through the FlexTest application. The option is available in the 'Advanced' menu.

19.0 - CR4300 Maintenance

The CR4300 needs only minimum maintenance to operate. The tips below for maintenance suggestions.

Cleaning the CR4300

If the unit becomes dirty, clean it with a soft, non-abrasive cloth that has been moistened with water. If a disinfectant must be used, please refer to the approved cleaner list at www.codecorp.com and use only cleaners listed to avoid unit damage. Unit should not be soaked or sprayed under any circumstances. Spray the cloth you're using, not the unit. If a non-approved cleaner is used, the product warranty may be voided.

Technical Support and Returns

For user specific configurations or support, visit www.codecorp.com/codesupport.php. For all returns, Code will issue an RMA number that must be placed on the packing slip when the reader is returned. Visit www.codecorp.com/codesupport.php for more information.

20.0 - Warranty

Visit www.codecorp.com/warranty for warranty coverage terms.

Limited Warranty

Code warrants each Code product against defects in materials and workmanship under normal use for the Warranty Coverage Term applicable to the product as described at www.codecorp.com/legal/warranty/term.php. If a hardware defect arises and a valid warranty claim is received by Code during the Warranty Coverage Term, Code will either: i) repair a hardware defect at no charge, using new parts or parts equivalent to new in performance and reliability; ii) replace the Code product with a product that is new or refurbished product with equivalent functionality and performance, which may include replacing a product that is no longer available with a newer model product; or iii) in the case of failure with any software, including embedded software included in any Code product, provide a patch, update, or other work around. All replaced products become the property of Code. All warranty claims must be made using Code's RMA process.

Exclusions

This warranty does not apply to: i) cosmetic damage, including but not limited to scratches, dents, and broken plastic; ii) damage resulting from use with non-Code products or peripherals, including batteries, power supplies, cables, and docking station/cradles; iii) damage resulting from accident, abuse, misuse, flood, fire or other external causes, including damage caused by unusual physical or electrical stress, immersion in fluids or exposure to cleaning products not approved by Code, puncture, crushing, and incorrect voltage or polarity; iv) damage resulting from services performed by anyone other than a Code authorized repair facility; v) any product that has been modified or altered; vi) any product on which the Code serial number has been removed or defaced. If a Code Product is returned under a warranty claim and Code determines, in Code's sole discretion, that the warranty remedies do not apply, Code will contact Customer to arrange either: i) repair or replace the Product; or

20.0 - Warranty

ii) return the Product to Customer, in each case at Customer's expense.

Non Warranty Repairs

Code warrants its repair/replacement services for ninety (90) days from the date of shipment of the repaired/replacement product to the Customer. This warranty applies to repairs and replacements for: i) damage excluded from the limited warranty described above; and ii) Code Products on which the limited warranty described above has expired (or will expire within such ninety (90) day warranty period). For repaired product this warranty covers only the parts that were replaced during the repair and the labor associated with such parts.

Non Extension of Term of Coverage

Product that is repaired or replaced, or for which a software patch, update, or other work around is provided, assumes the remaining warranty of the original Code Product and does not extend the duration of the original warranty period.

Software and Data

Code is not responsible for backing up or restoring any of software, data, or configuration settings, or reinstalling any of the foregoing on products repaired or replaced under this limited warranty.

Shipping and Turn Around Time

The estimated RMA turn-around time from receipt at Code's facility to shipment of the repaired or replaced product to Customer is ten (10) business days. An expedited turn-around time may apply to products covered under certain CodeOne Service Plans. Customer is responsible for shipping and insurance charges for shipping Code Product to Code's designated RMA facility and repaired or replaced product is returned with shipping and insurance paid by Code. Customer is responsible for all applicable taxes, duties, and similar charges.

Transfer

If a customer sells a covered Code Product during the Warranty Coverage Term, then that coverage may be transferred to the new owner by written notification from the original owner to Code Corporation at:

CodeOne Service Center
12393 South Gateway Park Place, Suite 600
Draper, UT 84020

Limitation on Liability

Code's performance as described herein shall be Code's entire liability, and the Customer's sole remedy, resulting from any defective Code product. Any claim that Code has failed to perform its warranty obligations as described herein must be made within six (6) months of the alleged failure. Code's maximum liability related to its performance, or failure to perform, as described herein shall be limited to the amount paid by Customer for the Code product that is subject to the claim. In no event will either party be liable for any lost profits, lost savings, incidental damage, or other economic consequential damages. This is true even if the other party is advised of the possibility of such damages.

EXCEPT AS MAY BE OTHERWISE PROVIDED BY APPLICABLE LAW, THE LIMITED WARRANTIES DESCRIBE HEREIN REPRESENT THE ONLY WARRANTIES CODE MAKES WITH RESPECT TO ANY PRODUCT. CODE DISCLAIMS ALL OTHER WARRANTIES, WHETHER EXPRESSED OR IMPLIED, ORAL OR WRITTEN, INCLUDING WITHOUT LIMITATION IMPLIED WARRANTIES OF MERCHANTABILITY, FITNESS FOR A PARTICULAR PURPOSE AND NON-INFRINGEMENT.

THE REMEDIES DESCRIBED HEREIN REPRESENT CUSTOMER'S EXCLUSIVE REMEDY, AND CODE'S ENTIRE RESPONSIBILITY, RESULTING FROM ANY DEFECTIVE CODE PRODUCT.

CODE SHALL NOT BE LIABLE TO CUSTOMER (OR TO ANY PERSON OR ENTITY CLAIMING THROUGH CUSTOMER) FOR LOST PROFITS, LOSS OF DATA, DAMAGE TO ANY EQUIPMENT WITH WHICH THE CODE PRODUCT INTERFACES (INCLUDING ANY MOBILE TELEPHONE, PDA, OR OTHER COMPUTING DEVICES), OR FOR ANY SPECIAL, INCIDENTAL, INDIRECT, CONSEQUENTIAL OR EXEMPLARY DAMAGES ARISING OUT OF OR IN ANY MANNER CONNECTED WITH THE PRODUCT, REGARDLESS OF THE FORM OF ACTION AND WHETHER OR NOT CODE HAS BEEN INFORMED OF, OR OTHERWISE MIGHT HAVE ANTICIPATED, THE POSSIBILITY OF SUCH DAMAGES.